

Avery Dennison Sustainable ADvantage





Sustainable ADvantage:

Our flagship products and solutions

More brands are moving toward sustainable packaging so that they can meet consumer demand, stay ahead of regulations and improve the environment.

The materials in our Sustainable ADvantage portfolio make it easy to improve the environmental impact of packaging without sacrificing performance—and in many cases, without paying more.

Sustainable ADvantage enables our customers to reduce their environmental footprint, satisfy consumer demand, increase recyclability, and respond effectively to government regulations. As a showcase of our mission to build towards regeneration, Sustainable ADvantage enables circularity, improves environmental performance and facilitates transparency across the entire supply chain.

2030 Sustainability Goals

Avery Dennison's commitment
towards a circular economy

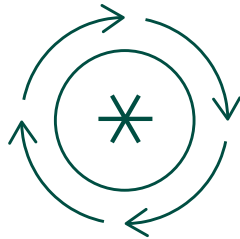

Goal 1:

Deliver innovations that
advance the circular
economy

We implement and advance technologies to enable recyclability, extend the lifespan of materials, reduce waste, increase recycled content, and integrate opportunities for circular processes across our industries. By collaborating with our customers and suppliers, we can deliver a more sustainable future.



Goal 2:

Reduce the environmental
impact in our operations
and supply chain

We reduce our environmental footprint by decreasing our greenhouse gas (GHG) emissions, increasing our water efficiency and protecting the forests from which our products are derived. As a leader in our industries, we engage with our suppliers, customers and value chain partners to drive change that protects our climate and ecosystems.

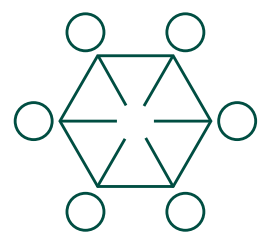

Goal 3:

Make a positive impact by
enhancing the livelihoods
of our employees and
communities

We champion transparency, collaboration, equality, diversity and inclusion. Our business contributes to the economic livelihoods of people and communities across our value chain. We serve as a force for good in our operations by promoting safety and enhancing the employee experience, as well as in our communities by investing in programs that advance women's empowerment, sustainability and education.

The solutions in our Sustainable ADvantage portfolio meet one or more of these criteria:



Contains recycled or renewable content

Give a second life to what has already been used

Facestocks and liners that include post-industrial waste or post-consumer recycled content



Reduction in the use of materials

Use only what is necessary

Thinner facestock, adhesive, or liner that uses less raw materials to be manufactured



Enables recycling, reuse or compostability

What we use can be used again

Solutions that enable the reuse and recycling of packaging as well as the recycling and composting of label waste



Responsibly sourced

Products sourced from a supply chain that shows care for people and the environment

Film made from renewable alternatives and paper certified by FSC® or other organizations

Life Cycle Assessment

Sustainability results you can measure

Avery Dennison Life Cycle Assessment Tool quantifies the environmental impacts of the labels in our sustainability portfolio across six different categories.

The scope of the analysis is from material extraction to processing by Avery Dennison, to end-of-life, which helps you easily visualize potential environmental savings, providing greater transparency of your materials' impact and stronger confidence in your decision-making.



Energy consumption



Fossil material consumption



Biobased material consumption



Greenhouse gas emissions



Water consumption



Solid waste generation

AD Circular

The Avery Dennison liner recycling program

Label waste is not always visible on the final packaging, but its impact on brand reputation is no less real.

For the effective recycling of glassine liners, a proper waste collection system and separation technologies must be in place.

Avery Dennison continues to add suitable recyclers to our AD Circular program, making it easier for converters and brand owners to take part in creating a circular economy and secure their sustainability credentials.

(The availability of the program may vary among Avery Dennison operating sites)



Packaging Recyclability

To create sustainable packaging, we must adopt label technologies that reflect a whole systems approach—from materials design to end-use—and work in harmony with the existing recycling stream.

The waste hierarchy

The waste hierarchy is a set of priorities for the efficient use of resources that advances the circular economy. In place of the traditional waste management approach consisting of three Rs (Reduce, Reuse, Recycle), it shows a more elaborate waste management hierarchy – listing actions in order of priority, from least to most favourable from an environmental perspective

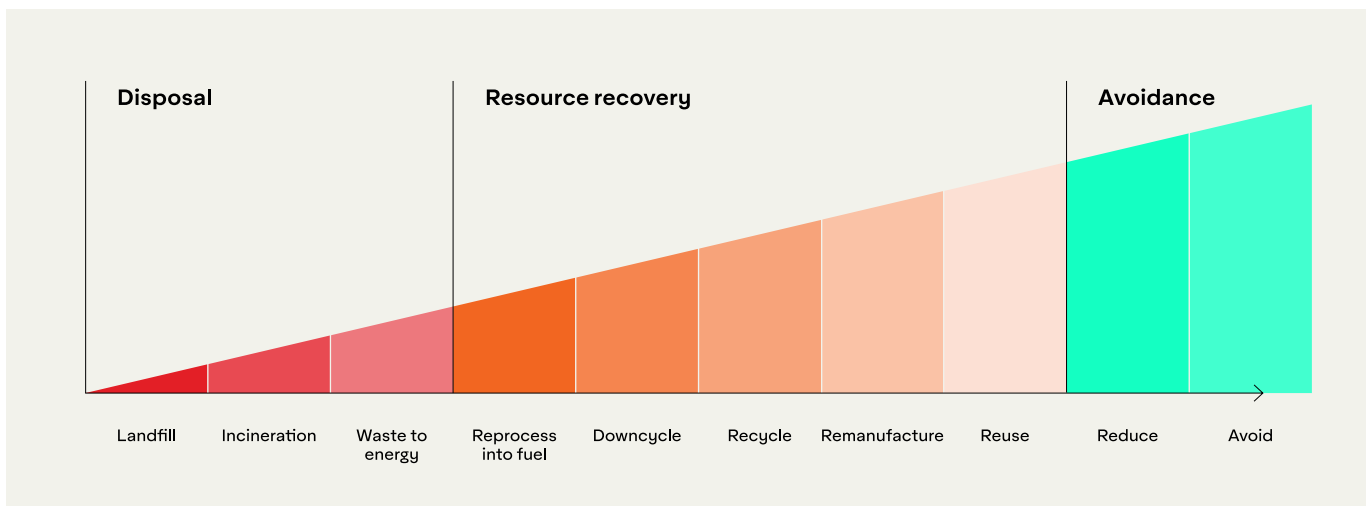

Downcycling

Packaging is recycled for lower grade applications

Example:

Food grade packaging fibers are recycled into industrial grade fibers

Recycling

Packaging is recycled for alternate applications

Example:

Food grade packaging fibers are recycled into non-food grade fibers

Remanufacturing

Packaging is recycled back into the same applications

Example:

Food grade packaging is remade into food grade packaging

What does it mean to be recyclable?

To be considered “recyclable”, a product has to be collected, sorted, processed, and applied – none of these processes can be missing.

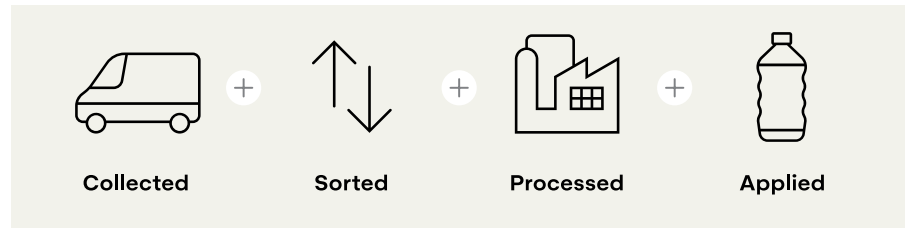

Ease of recycling various material types

	Paper and Cardboard	Glass	Metal Cans	PET	HDPE	PP	PS
Organised collection	●	●	●	●	●	●	●
Easy to separate	●	●	●	●	●	●	●
Availability of recyclers	●	●	●	●	●	●	●
Outlets for recycled materials	●	●	●	●	●	●	●
Food grade options for recyclates	●	●	●	●	●	●	●
Decoration impact on recyclability	●	●	●	●	●	●	●

Key: ● Technical challenges ● Some challenges ● Fully established

Main plastics types, applications and recycling potential



PET



HDPE



PVC



LDPE



PP



PS



EPS





OTHER

Bottle to bottle	Bottle to bottle	Limited options	Downcycled	Downcycled	Limited options	Limited options	Limited options
Water & soft drink bottles, salad domes, biscuit trays, salad dressing and peanut butter dressings	Milk bottles/ jugs, freezer bags, dip tubs, shopping bags, ice cream containers, juice bottles, shampoo bottles, chemical & detergent	Cosmetic containers, commercial cling wrap	Squeeze bottles, cling wrap, shrink wrap, rubbish/trash bags	Microwave dishes, ice cream tubs, potato chip bags, dip tubs	CD cases, water station cups, plastic cutlery, imitation crystal glassware, video cases	Foamed polystyrene hot drink cups, hamburger take-away clamshells, foamed meat trays, protective packaging for fragile items	Water cooler bottles, flexible films, multi-material packaging

What is the difference between chemical and mechanical recycling?

Chemical recycling describes innovative technologies where plastic waste is converted into feedstock that can be used to create new plastic products. Because chemical recycling methods and output varies, its environmental and economic impact are still being evaluated by the industry.

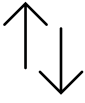
Mechanical recycling is a method by which waste materials are recycled into secondary raw materials without changing its basic structure. The material passes extensive manual or automated mechanical sorting processes in specialised facilities, designed to separate the different material streams. After the cleaning and grinding processes, the material is recovered by remelting and re-granulating. In terms of use, chemical recycling is a complementary solution to mechanical recycling, where the latter proves to be inefficient in case of difficult to recycle plastics, i.e. not properly sorted, multilayered, or heavily contaminated waste.

Recycling methods				
	 Collected	 Sorted	 Processed	 Applied
Mechanical recycling The four steps are part of the recycling process. Depending on these steps the waste finds its route either to:				
Bottle-to-bottle recycling		Perfect sorting and no contamination. Preferred route for circularity in the future.		Remanufactured into the same object, i.e. bottles
General plastic recycling		Sorting is not perfect but can be used in alternate applications. This is commonly the existing route.		Recycled into other applications, i.e. clothing, outdoor furniture, automotive parts
Chemical recycling Mixed plastics to virgin material quality		Sorting still required. Mixed material can be recycled back to its base and make material equivalent to virgin standards.		

Designing for Recyclability

Choosing the right label design for your product starts with understanding how the packaging protects your product, enhances consumer use, and enables a sustainable end-life.

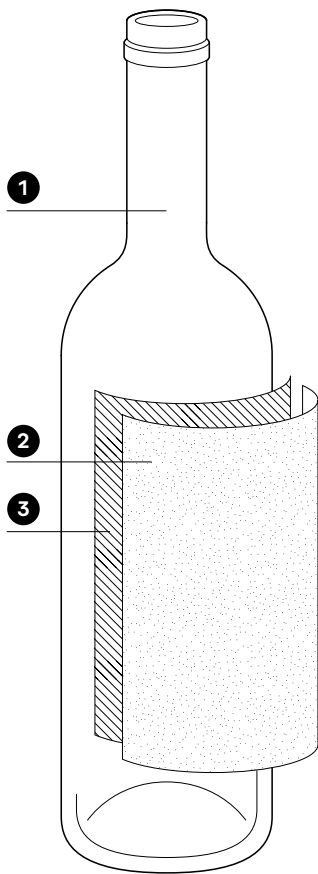

1

The container

Product

Choosing a container starts with the requirements of your product, including safe delivery of your product to the consumer, and meeting safety requirements and compliance regulations.

Use

Considering how consumers use your product is crucial for choosing the right container. Single-use products might do better in a plain, functional container, while products used daily may need a durable container that's more aesthetically pleasing to the consumer.

Afterlife

The lifecycle analysis of your product should include the packaging, as governments and consumers are looking to brands to create products that enable sustainability. If the container can't be recycled or reused, consumers may choose a product with packaging that can.

2

The label material

After the label material has met its compliance requirements, consider how its appearance will communicate the sustainability of your brand, product, and packaging. What material will convey your brand's sustainability focus best and look best on the shelf?

Ensuring the label can stand up to the use of the packaging is incredibly important for sustainability. If a label must be readable throughout the lifecycle of the product, a more durable material may be necessary. But for everyday products that consumers repeatedly buy and know how to use, perhaps a more minimal approach is appropriate.

When the product comes to the end of its life, how will the label material affect the recyclability of the packaging? For sustainable brands looking to make a meaningful waste reduction, a label that is recyclable or contains recycled content could be the right choice.

3

The adhesive

The combination of container, adhesive, and label can affect the legibility of the label, which could affect compliance, sustainability, and consumer use. If these are important to your product, you'll need to choose an adhesive that works with you.

Ensuring the label stays adhered for as long as necessary is an important consideration. A member of our team can help you choose an adhesive that works with your application and helps your brand meet your sustainability goals.



A label shouldn't hinder the recyclability or reusability of the packaging material. When a product has finished its consumer life and is ready for the waste (or recycle) stream, how will the adhesive affect its sustainability? Make sure you choose an adhesive technology like CleanFlake technology that enables the recyclability of your product.



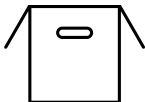

Let's find the right products for you.

Our teams love recommending exactly the right Avery Dennison product for your specific applications.

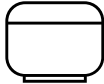
To talk more about Sustainable ADvantage products, contact your local Avery Dennison sales representative or visit label.averydennison.com.

Our sustainable solutions for each packaging substrate

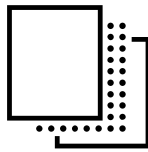
	Cardboard	PET	HDPE	PP
Packaging substrate				
Key end use segments	<ul style="list-style-type: none"> Transport Logistics 	<ul style="list-style-type: none"> Beverage Food HPC 	<ul style="list-style-type: none"> Food Beverage HPC 	<ul style="list-style-type: none"> Dairy HPC (minor)
Label types and technologies	<ul style="list-style-type: none"> Paper DT (PSL) 	<ul style="list-style-type: none"> PP (wrap around) PP, Paper (PSL) Sleeves 	<ul style="list-style-type: none"> Paper (wet glue) PE, MDO, paper (PSL) Sleeves 	<ul style="list-style-type: none"> Direct print Paper (wet glue) PP (PSL)
Label separation process	Repulping	Sink float	Sink float & air blow (bottle to bottle)*	Sink float & air blow
Current Avery Dennison solutions	Standard paper/ VI labels	CleanFlake™ technology	Monomaterial packaging (HDPE)	Monomaterial packaging (PP)

	PS	Glass	Compostable foil	Flexible packaging
Packaging substrate				
Key end use segments	<ul style="list-style-type: none"> Food Beverage 	<ul style="list-style-type: none"> Beverage Food 	<ul style="list-style-type: none"> Food Retail 	<ul style="list-style-type: none"> HPC (wet wipes) Food
Label types and technologies	<ul style="list-style-type: none"> Direct print Paper (wet glue) 	<ul style="list-style-type: none"> Paper (wet glue) Paper, PP (PSL) 	<ul style="list-style-type: none"> Paper (PSL) 	<ul style="list-style-type: none"> PP, PET, PE (PSL) In some cases combination of PET and PP or PET and PE label layers
Label separation process	Brush off paper label	Washing, sorting (visual & mechanical)	Industrial composting	<p>No established recycling so far, CEFLEX advocating for monomaterial PE/PP</p> <p>In food PVDC-free OXYB solutions are preferred</p>
Current Avery Dennison solutions	Monomaterial packaging (PS)	Wash off/ glass recycling solutions	Monomaterial and compostable labels	Monomaterial PE/PP labels PVDC-free OXYB PP labels

Contains recycled or renewable content

Give a second life to what has already been used

Facestocks and liners that include post-industrial waste or post-consumer recycled content

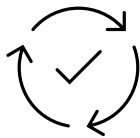

rPP

Made with 30% recycled PP resin, rPP is designed for brands that seek to increase the recycled content of their packaging without the need to alter brand aesthetics.



rDT

The first recycled non top-coated DT paper in the market, rDT features 15% post consumer waste in its construction. An ideal solution for thermal applications that focus on sustainability, rDT gives similar performance to our standard grade facestock.



rPET Liner

Made partially from recycled PET plastic, rPET liner is the thinnest filmic liner currently in the market (23 microns).



Sustainable Wine Labels

Avery Dennison offers a variety of premium labels containing up to 100% recycled content or crop waste.



Biomass Balance

An emulsion adhesive that consists of 30% raw materials originating from renewable resources, providing a more sustainable solution for paper labels.

Reduction in the Use of Materials

Use only what is necessary

Thinner facestock, adhesive, or
liner that uses less raw materials
to be manufactured



PE75

A fully conformable and squeezable label that provides high conversion speed, greater operational productivity, cost efficiencies, and is paired with the thinner BG33 glassine liner for greater sustainability advantage.



PP40

The thinnest film label, ideal for high-speed labelling needs.



Global MDO

A semi-squeezable construction that improves conformable labelling. Engineered to provide a balance of rigidity and conformability with excellent strength and stability that enable the widest operating window.

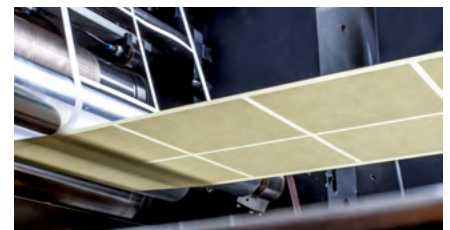

BG33 Liner

A thinner FSC certified liner paired with Avery Dennison's rPP and rPET labels.

Enables recyclability, reuse, or compostability

What we use can be used again

Solutions that enable the reuse and recycling of packaging as well as the recycling and composting of label waste

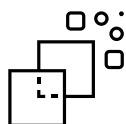

CleanFlake™

Features a breakthrough adhesive that eliminates contamination of PET plastic by allowing label and container to neatly part ways during the recycling process, improving yields of recycled PET plastic. Also suitable for HDPE recycling.



HDPE Recycling

Film labels combined with emulsion acrylic adhesive that enhance the recyclability of high-density polyethylene containers. Certified by the Association of Plastic Recyclers as a reliable mono-material solution.

Responsibly sourced

Products sourced from a supply chain that shows care for people and the environment

Film made from renewable alternatives and paper certified by FSC® or other organizations



Sustainable Wine Labels

Facestocks made with responsibly-sourced ingredients, such as using cotton linters, agri-industrial by-products or bagasse fiber



FSC® Certified

The industry's widest selection of facestocks certified by the Forest Stewardship Council®, with more than 80% of the paper products purchased made with FSC certified wood fiber.

Glossary

Biomass

Material of biological origin, excluding material embedded in geological formations or transformed to fossilized material and excluding peat.

Closed-loop system

A system in which materials are reclaimed, returned to, and reused at the same material technical application equivalence or performance specifications as when the material was first used.

Compostability

A characteristic of a product, packaging, or associated component that allows it to biodegrade, generating a relatively homogeneous and stable humus-like substance.

Degradable

A characteristic of a product or packaging that, with respect to specific conditions, allows it to break down to a specific extent within a given time.

Eco design

A multi-disciplinary and criteria-based process to develop products that have the best positive social, environmental, and financial impact. The guideline for the whole development process, from ideation to implementation, on how our products impact the value chain.

Extended producer responsibility (EPR)

A policy tool that extends the producer's full or partial financial and/or operational responsibility for a product to the postconsumer state of a product's life cycle in order to help meet national or regional recycling and recovery targets.

Greenhouse gas (GHG)

Gaseous constituent of the atmosphere, both natural and anthropogenic, that absorbs and emits radiation at specific wavelengths within the spectrum of infrared radiation emitted by Earth's surface, atmosphere, and clouds.

Green chemistry

The utilisation of a set of principles that reduces or eliminates the use or generation of hazardous substances in the design, manufacture, and application of chemical products.

Life cycle

Consecutive and interlinked stages of a product system, from raw material acquisition or generation from natural resources to final disposal.

Pre-consumer/post industrial waste

Material diverted from the waste stream during a manufacturing process. Excludes reutilization of materials such as rework, regrind, or scrap generated in a process and capable of being reclaimed within the same process that generated it.

Post-consumer waste /post consumer recycled

Material generated by households or by commercial, industrial, and institutional facilities in their role as end-users of the product, which can no longer be used for its intended purpose. Includes returns of material from the distribution chain.

Post-consumer resin

A plastic that has been re-processed to be re-used in manufacturing, and consists of blended or recycled resins that would have otherwise become waste.

Post-industrial resin

Plastic waste recovered from industrial processes. Consists of blend or recycled resins coming from industrial waste. In contrast to PCR, PIR is recycled plastic that never left the manufacturing floor (and therefore never made it to the consumer).

Recovered material

Material that would have otherwise been disposed of as waste or used for energy recovery, but has instead been collected and recovered as a material input, in lieu of new primary material, for a recycling or a manufacturing process.

Recyclable

A characteristic of a product, packaging, or associated component that can be diverted from the waste stream through available processes and programmes and can be collected, processed, and returned to use in the form of raw materials or products.

Recycled content

Proportion, by mass, of recycled material in a product or packaging; only preconsumer and post-consumer materials are considered recycled content.

Recycled material

Material that has been reprocessed from recovered [reclaimed] material by means of a manufacturing process and made into a final product or into a component for incorporation into a product.

Refillable

A characteristic of a product or packaging that can be filled with the same or similar product more than once, in its original form and without additional processing, except for specified requirements such as cleaning or washing.

Renewable material

Material that is composed of biomass from a living source and that can be continually replenished.

Reusable



A characteristic of a product or packaging that has been conceived and designed to accomplish within its life cycle a certain number of trips, rotations or uses for the same purpose for which it was conceived.

Upgradability

Characteristics of a product that allows its modules or parts to be separately upgraded or replaced without having to replace the entire product.

Definitions ISO 14021:2016(E) and UL 2809: 2019

Find more sustainable label solutions at label.averydennison.com

Connect with us on:   



DISCLAIMER – All Avery Dennison statements, technical information and recommendations are based on tests believed to be reliable but do not constitute a guarantee or warranty. All Avery Dennison products are sold with the understanding that purchaser has independently determined the suitability of such products for its purposes. All Avery Dennison's products are sold subject to Avery Dennison's general terms and conditions of sale, see <http://terms.averydennison.com>. © 2024 Avery Dennison Corporation. All rights reserved. Avery Dennison and all other Avery Dennison brands, this publication, its contents and product names and codes are owned by Avery Dennison Corporation. All other brands and product names are trademarks of their respective owners. This publication must not be used, copied or reproduced in whole or in part of purposes other than marketing by Avery Dennison.